

SPIROTECH SPECIFICATION SHEET



Product: **elko-flex
N25**

Type:
Date:

EVN25
1/15/2024

Customer:

Project:

Reference:

Drawing



EVN 4 .. EVN 100, EVN 140

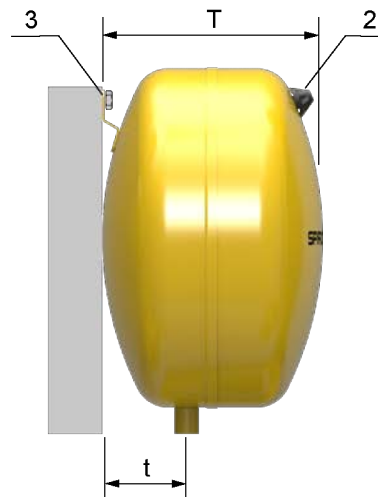

EVN 4 .. EVN 100

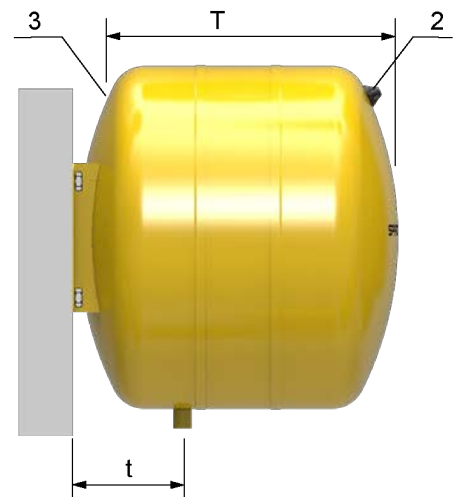

EVN 140

Design criteria

Tested in accordance with:	PED 2014/68/EU	
Max. safety temperature of the system without/with cooling vessel:	90/110	°C
Min. Temperature:	0	°C
Max. temperature:	70	°C
Max. pressure:	3	bar-g
Permissible medium:	Water, Water/Glycol	
Color:	RAL 1003	

Dimensions

D:	400 mm
T:	252 mm
t:	90 mm
Connection	Rp3/4
1	Expansion pipe
2	Gas pressure valve
3	Wall mount (1)
Volume:	25 ltr
Dry weight (approx):	5 kg

Subject to changes